

Natural and Anthropogenic Radionuclides in Date Fruit from the United Arab Emirates: a Baseline Study.



Dr. Rubina Rahman

Visiting Research Scholar (Khalifa University), Abu Dhabi, UAE
 Associate Professor, Physics Department
 Jahangirnagar University, Dhaka, Bangladesh &
 Honorary Research Fellow, University of Liverpool, UK



HYPOTHESIS

- An Agreement between UAE and Korea in 2009 to deploy 4 NPP (1400 MWe) at Barakah, Abu Dhabi by 2020
- Yet, no radiation baseline data has been found in any scientific literature on environmental samples of UAE except a very recent theoretical based model study
- Most importantly, before operating any Nuclear Power Plant like BNPP, it is important to have radioactivity baseline data on environmental samples
- All these aspects lead the present study to conduct a quantitative radioactivity research on date palm fruits and adjacent soils of date collection trees (i.e. per farm).



Fig. 1 (source): Sung-yeop Kim et al. (2013). *Applied Radiation and Isotope*; 81, pp. 190–195.

(2)



Significance of the proposed Research

- The present study will be the first study:
 - to determine the background radiation levels in date fruits in the UAE and
- It will provide baseline data for future studies to determine contamination level due to any fallout deposition of radionuclides or even in any emergency case of nuclear accident outside UAE or within UAE due to any BNPP operation in near future.



3



Why Date fruit: chosen sample in present study?

- As date fruit (*Phoenix dactylifera L.*) has become an integral part of heritage and identity of the UAE as it owned third of the world's trade of dates, coming in first in exports, and second in imports in 2009
- Over 44 million date palms in the UAE can be grouped under 199 different varieties and together produced 76,000 tons of fruit in 2011
- Furthermore, Food & Agriculture Foundation (FAO) announced Liwa and Al Ain date palm oases as “Globally Important Agricultural Heritage Systems”, for their importance as repositories of genetic resources
- Hence, to establish a radiation baseline data from various date fruit farms within the UAE, it was decided to select date fruits to be the focus point of research in present study.

4



Cont. Why Date fruit: chosen sample in present study?

TOP TEN DATE PRODUCING COUNTRIES

The UAE accounts for 11.4 per cent of global date production. The date production of 35 countries was estimated. The Middle East and Asia are the main producers of dates. The diagram below shows that the UAE occupies the fourth position in the world after Egypt, Iran and Saudi Arabia. It also comes third among Arab countries after Egypt and Saudi Arabia. The UAE has accomplished a complete local production of dates.

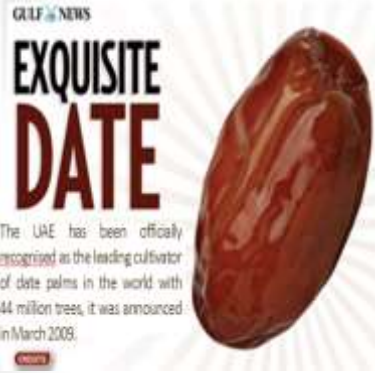

Space devoted to palm trees in the UAE and the world

Country	(1,000 Hectares)	% of Total Production	Rank
UAE	186	18.2	1
Iran	185	18.1	2
KSA	145	14.2	3
Algeria	135	13.2	4
Pakistan	81.7	8	5
Morocco	48	4.7	6
Tunisia	45	4.4	7
Sudan	35	3.4	8
Egypt	34.5	3.4	9
Oman	34	3.3	10



Radiation Exposure pathways to man:

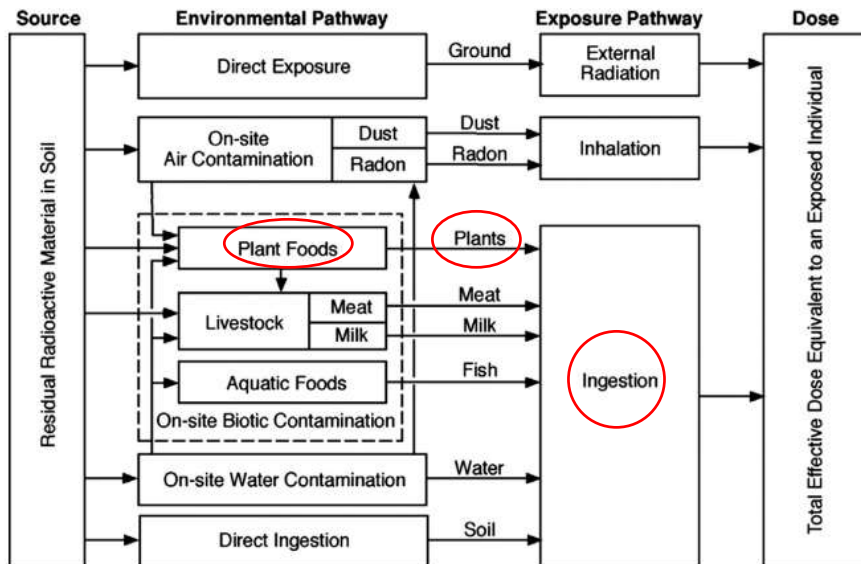

6



Aim of the study?

- To establish a reference base-line radiation data on date fruit samples to assess any changes in the background levels due to geological processes, fallout deposition or radiation releases from any of the BNPP's, in near future
- To measure and report the **radioactivity concentration** (A) (for both dry and fresh weight conditions of pitted dates) along with the **total annual effective doses** and the **equivalent radium** (R_{eq}) resulted from both natural and anthropogenic radionuclides of date fruits as well as of soil samples
- Estimated **total uncertainties** within the results of all samples will be reported in this project

7



Sample Collection:

- All Dates (Tamer stage) were collected with the help of FANR
- No of sample collected: Total 40 samples: 22 from 2014 & 18 from 2015
- Locations of samples: Al Silaa, Liwa, Ghayathy and Sih Al Khair
- No of varieties: 12 varieties of date fruits.

The main varieties and specifications of collected date fruits in present study:

Sl. no.	Name	Maturity	Shape	Colour
1	Dabbas	August	Medium & Thick	Light dark brown
2	Neghal	August	Long & Thin	Dark brown
3	Bumann	August.	Short &Thick	Light brown
4	Bahri	September	Round	Yellow
5	Shishi	September	Medium & Thick	Light brown
6	Lulu Red	September	Short &Thick	Light brown
7	Khalas	October	Medium & Thick	Light brown
8	Khenaizi	October	Medium & Thick	Medium brown
9	Rezaiz	October	Medium & Thick	Light dark brown
10	Yardi	October	Short & Thick	Light brown
11	Khadi	October	Short &Thick	Light brown
12	Zahedi	October	Short &Thick	Light brown



8



Sample Preparation:

- Seeds are removed from all dates and dried in conventional electric oven at 80 °C for 1-2 weeks for complete dryness
- Dried dates are then grinded and poured into Marinelli Beakers (MB) with sealing the end caps of MB's with scotch tape to make them airtight and left for ca. 4-5 weeks
- To allow the short lived natural-series progeny to reach secular equilibrium of ^{226}Ra with its decay products in the Uranium series and ^{228}Ra with its daughters in the Thorium series.



9



Gamma measurement configurations:

- **Sampling geometry:** Marinelli Beaker (2L)
- **Counting time:** 24 hrs
- **Energy calibration:** Using Eu-152 point source
- **Ref. Eff. Curve:** Multinuclide wax source containing ^{137}Cs , ^{241}Am and ^{152}Eu
- **Efficiency calibration:** Efficiency calibration will be done using ANGLE software where "efficiency transfer (ET)" principle is used and ET factor is the ratio of the actual to reference efficiency at a given gamma-energy
- **Detector specification:** P-type coaxial HPGe detector
- **Spectrum analysis:** Gamma vision software
- **Interested radionuclides:** Gamma-peaks for ^{226}Ra (^{238}U) and ^{232}Th series, ^{40}K , ^{137}Cs and all other significant peaks (if any).

10



Detector specifications:

- KU Detector: EG&G ORTEC GEM40P4 HPGe detector.
- Detector type: P-type HPGe detector
- Relative detection efficiency: 40%
- Energy resolution: 1.85 keV for 1.33 MeV peak of ^{60}Co
- Automated sample changer for up to 20 samples
- Laminar shield for low background counting
- Mechanical cooling system (no LN2 required)

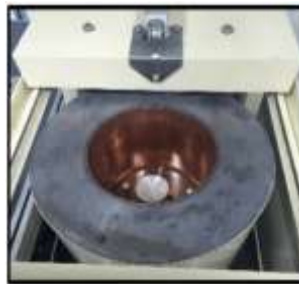

11



ANGLE software for efficiency calibration: An overview

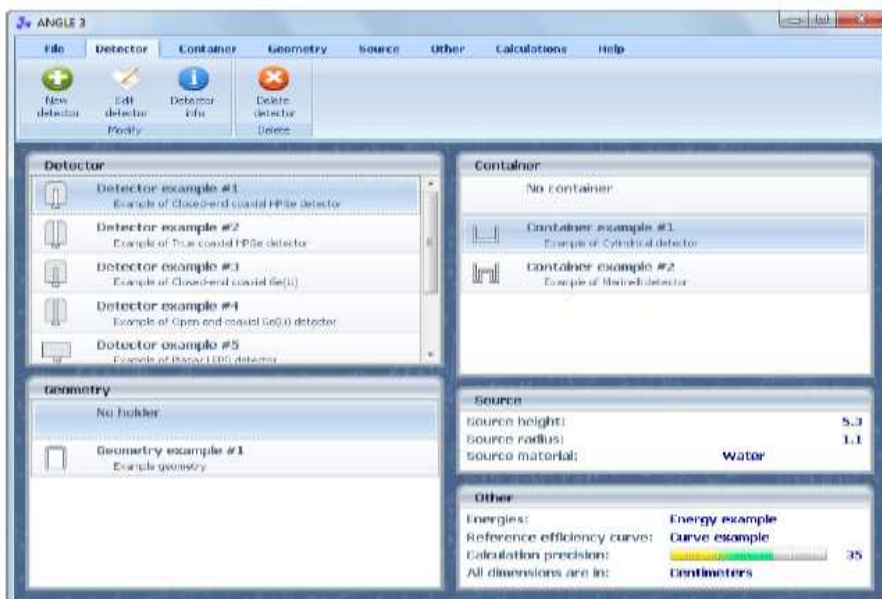

Cont. ANGLE software: An overview

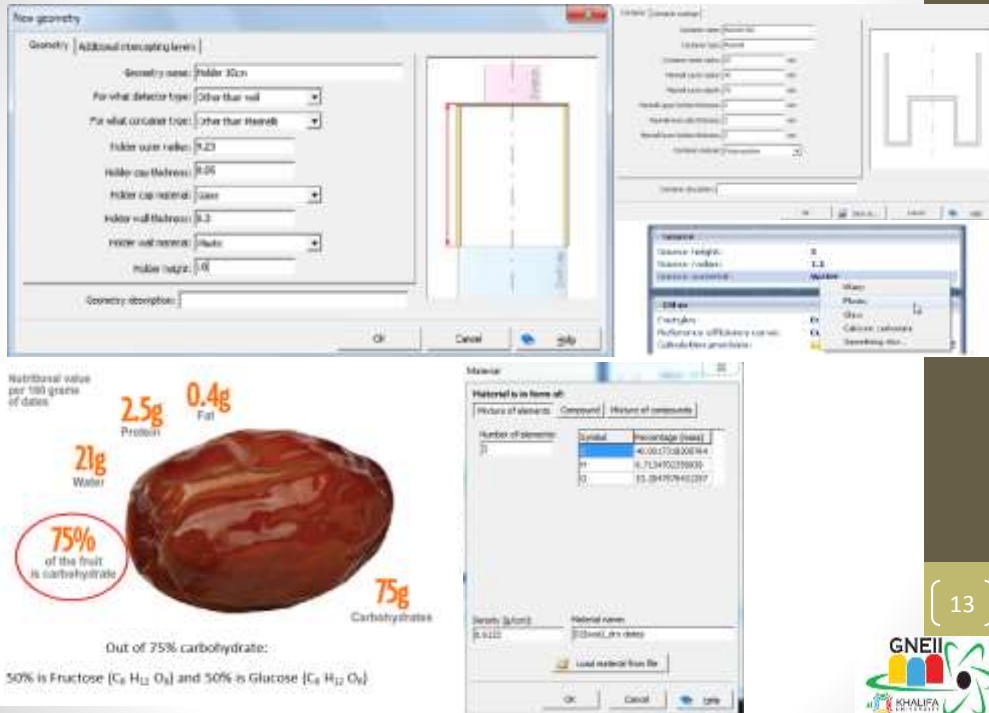

Nutritional value per 100 grams of dates:

- 2.5g Protein
- 0.4g Fat
- 21g Water
- 75% of the fruit is carbohydrate
- 75g Carbohydrates

Out of 75% carbohydrate:
50% is Fructose ($C_6H_{12}O_6$) and 50% is Glucose ($C_6H_{12}O_6$)

Number of elements	Symbol	Percentage (mass)
1	C	40.00270828194
1	H	6.71849229806
1	O	53.28479741207

Material name:

Load material from file:

13

GNEII
KHALIFA UNIVERSITY

Cont. ANGLE software: An overview



- ❑ After exporting the output file from ANGLE to gamma vision software, it is saved as an EFT. File in gamma vision software
- ❑ Then destroying current Eff. Calibration, new calibration file for the specific sample is created, saved and recalled during gamma spectrum analysis.

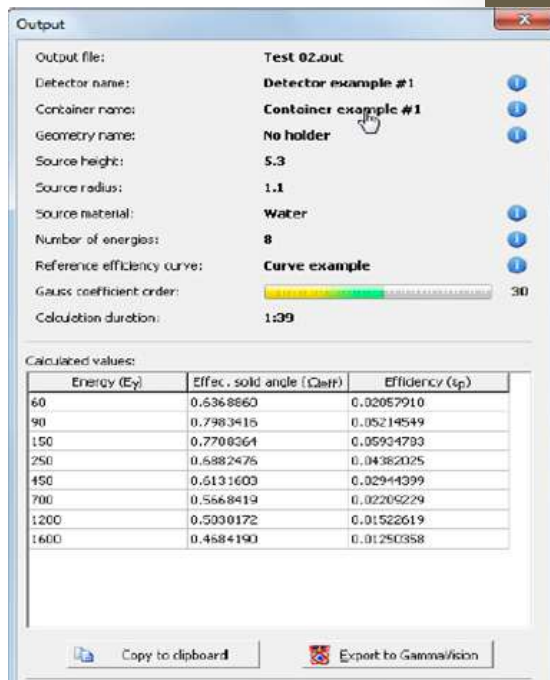

Energy (E _γ)	Effec. solid angle (Ω _{eff})	Efficiency (ε _p)
60	0.6368863	0.02057910
90	0.7983415	0.05214549
150	0.7708364	0.05924793
250	0.6882476	0.04382025
450	0.6131603	0.02944399
700	0.5668419	0.02209229
1200	0.5030172	0.01522619
1600	0.4684190	0.01250358

Copy to clipboard | Export to GammaVision

Example Energy and Efficiency calibration curves:

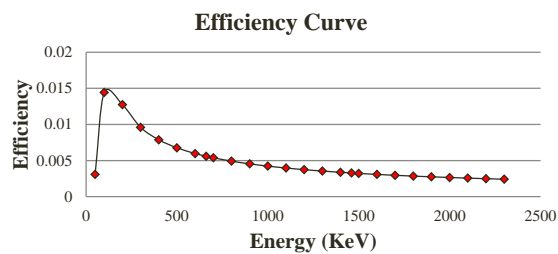
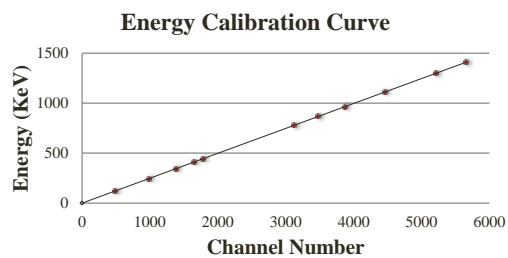

15



Radioactivity and MDA calculations:

Radioactivity Equation :

The activity concentration A (Bq kg^{-1}) of each of the radionuclide in each sample will be calculated using formula :

$$A = \frac{N}{\epsilon P_{\gamma} m t}$$

where, N is the observed net count rate over time period t at the specified gamma energy, ϵ is the counting efficiency of the detector at the measured gamma energy, P_{γ} is the intensity of the measured gamma emission and m is the mass of date sample in kg.

Minimum Detectable Activity Equation:

The minimum detectable activity (MDA) will be calculated using formula (Currie 1967):

$$MDA = \frac{2.71 + 4.66 S_b}{\epsilon P_{\gamma} t m}$$

where S_b is the standard error in the net background count rate for the photopeak.

16



Dose calculations:

The annual effective dose from consumption of palm dates will be calculated using the formula (UNSCEAR 2000):

$$D = AEI,$$

where ,

- **D** is the annual effective dose (Sv y^{-1}),
 - **A** is the average activity concentration for the radionuclide (Bq kg^{-1}) dry weight,
 - **E** is the dose conversion factor for the radionuclide (Sv Bq^{-1}), and
 - **I** is the annual intake of date fruits (kg)
- Value **E** will be selected based on the International Commission on Radiological Protection (ICRP) classifications (ICRP 1996)
 - The value of **I** will be taken as 41 kg y^{-1} (wet weight) in accordance to obtain data considering the relatively high average consumption of dates per capita in the UAE nation's. (c) 2006 Society of Chemical Industry which corresponds to daily consumption of dates per capita as 114.3 g, equivalent to 10 date fruits (Baraem I. et al. 2006).

17



Sample Preparation method validation test:



1) Whole fresh dates (with seeds)



2) Fresh dates (without seeds)



3) Dry dates (without seeds)



4) Dry powdered dates (without seeds)

Gamma measurements will be taken place for four prepared conditions of same variety of date fruit sample sealed in four 2L MBS:

- to look whether the results are same for all or not?

18



ANGLE software validation test:

The computational approach for calculating efficiencies using ANGLE software will be validated measuring correct activities of known volumetric samples (IAEA samples) and point sources through some sensitivity and method validation tests:

- ❑ Calculating measured activity changing input parameters like source height, source density, source compositions and distance of source container from the detector end cap
- ❑ Finding correct measured activities of radionuclides comparing all variable input data in ANGLE with associate uncertainties.



19



Research Progress:

Work Progress (May-October 2015):

- ❑ Literature review and submission of Research Proposal in May 2015
- ❑ Writing methodology on date fruit sample preparation and existing user sample preparation manual of KU ERL has been modified
- ❑ Introduction part for the paper to be submitted in Journal
- ❑ Samples collection: 40 samples (22 from year 2014 and 18 from 2015)
- ❑ Sample preparation: 12 samples including test dates are dried, grounded and sealed for one month before gamma counting
- ❑ Operation instruction manual for ANGLE software and KU detector has been written for the users of KU detector
- ❑ γ - measurements:
 - Sample preparation methodology validation test &
 - ANGLE software validation tests are in progress.

20



Acknowledgements

- Sandia National Laboratory for funding on present project
- Dr Philip Beeley,
Professor of Practice and Chair, Nuclear Engineering, KUSTAR
& Director (GNEII)
- Dr Alexander Solodov,
Assistant Professor, Nuclear Engineering, KUSTAR;
Faculty Coordinator (GNEII)& PI/Mentor of present Project
- FANR, for sample collection and technical advises.

[21]



Thank you all !

[22]